

Article number: 60415221028

Description: Timing Belt Pulley 21 AT5 28/2

Measures

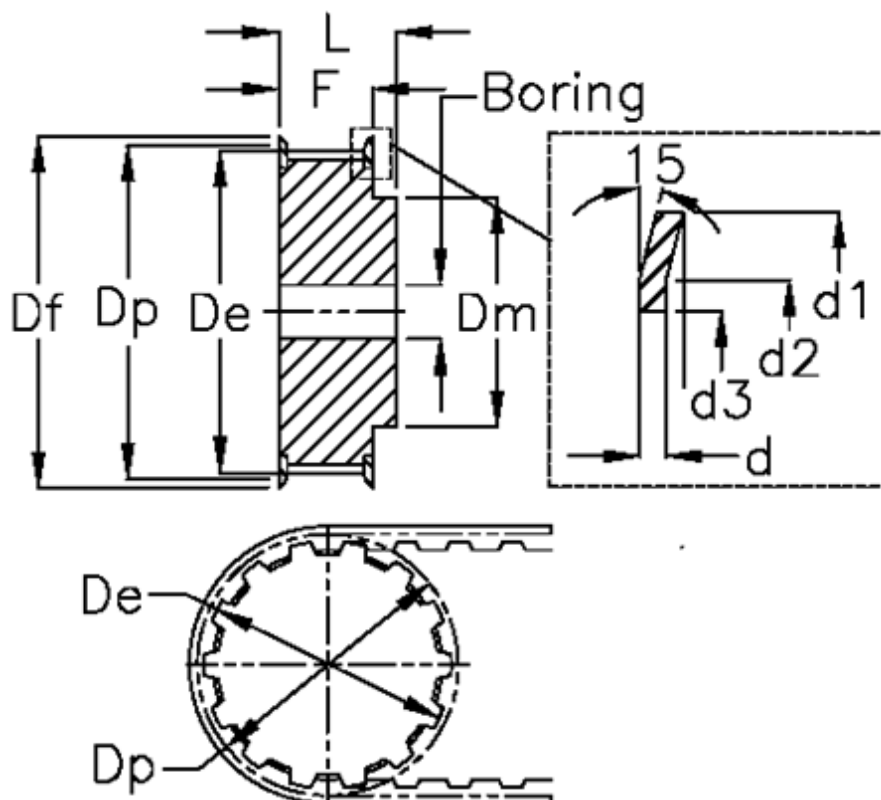

Belt width = - 10 mm	D_p	= 44.6
d = 1	F	= 15
d_1 = 48	Flange type	= F18
d_2 = 43.5	L	= 21
d_3 = 37	Pre-drilled	= 8
D_e = 43.35	Tooth number	= 28
D_f = 48	Type	= AT5
D_m = 32	Weight	= 0.071